

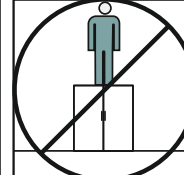

- | | |
|----------------------------------|-----------------------------|
| (GB) Assembly instructions | (PL) Instrukcja montażu |
| (DE) Montageanleitung | (CZ) Montážní návod |
| (FR) Notice de montage | (SK) Návod na montáž |
| (NL) Handleiding voor de montage | (HR) Montaže |
| (IT) Istruzioni di montaggio | (TR) Montaj talimat |
| (HU) Szerelési útmutató | (RO) Instrucțiuni de montaj |
| (ES) Instrucciones de montaje | (RU) Инструкция по монтажу |

szynakameble

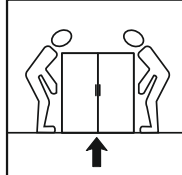
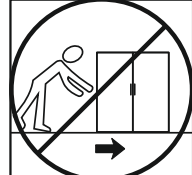
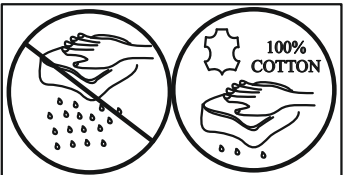
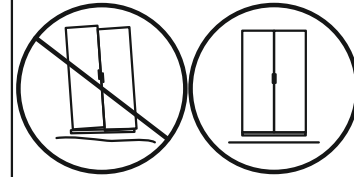
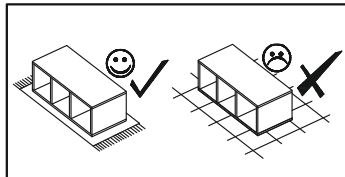
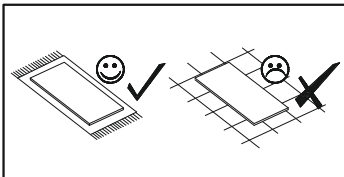
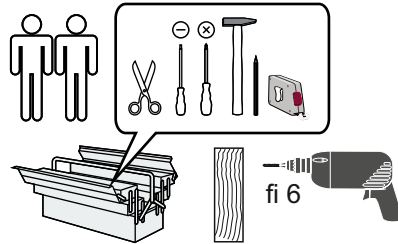
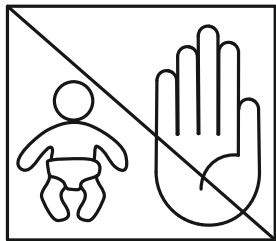
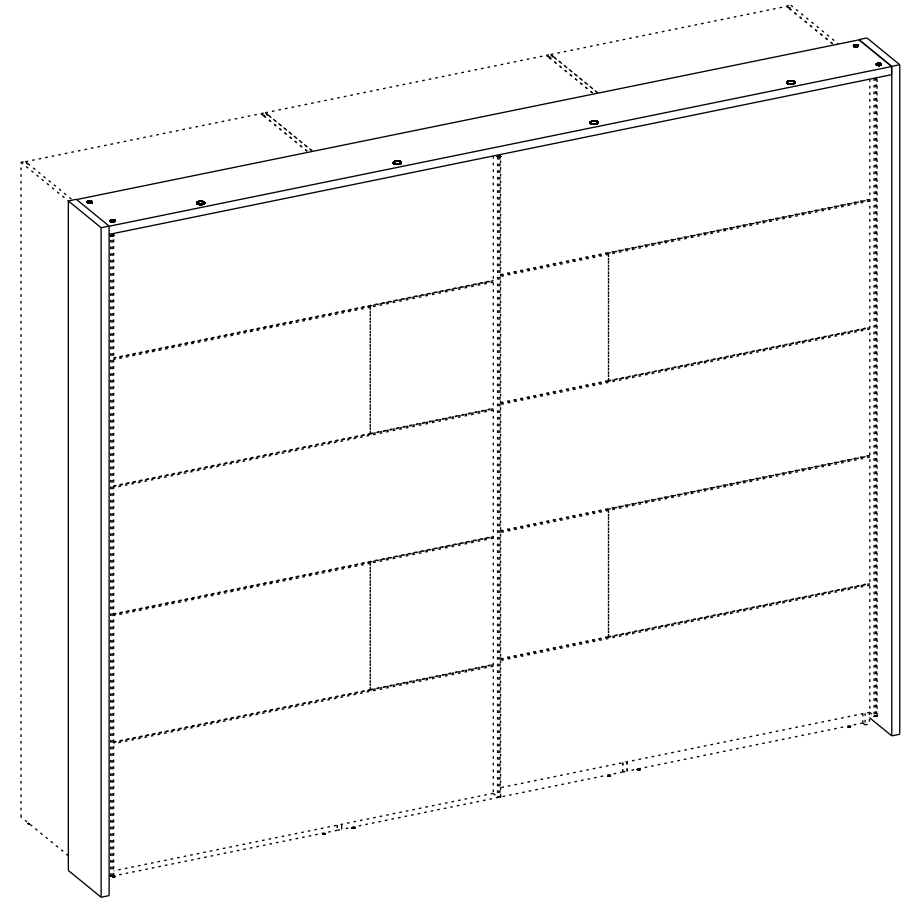

Service • Assistenza • Dienstverlening • Serwis Servis • Szerviz • Servicio • Usluga • Сервисная Служба

Name • Nom • Nome • Naam • Nazwa Jméno • Názov • Név • Denumire Nombre • Ime • Isim • Название	LIVORNO
Nr. • No. • N° • Номер • Č. • Sz. • Ne	
Typ • Type • Tip • Típus • Тіро • Тип	

shop • geschäft • boutique • sklep • winkel • магазин
negozio • bolt • tienda • obchod • dučan • maġaza • magazin

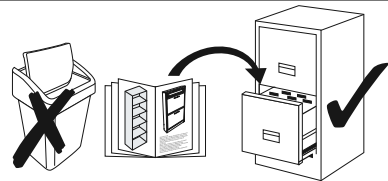
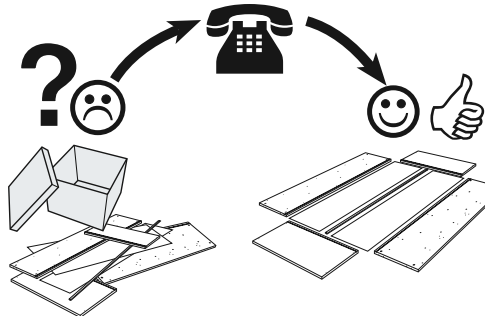

B1		x4
T1		x4
M1		x4
K1		x8
G7		x1
C2		x14
F15		x2
S13		x10
LED-01		x4
LED-ZA-01		x1

Nr	Ausmaß			St
1	2301	230	28	1
2	2301	230	28	1
3	2250	60	22	2
4	2745	229	28	1
5	2745	60	22	1

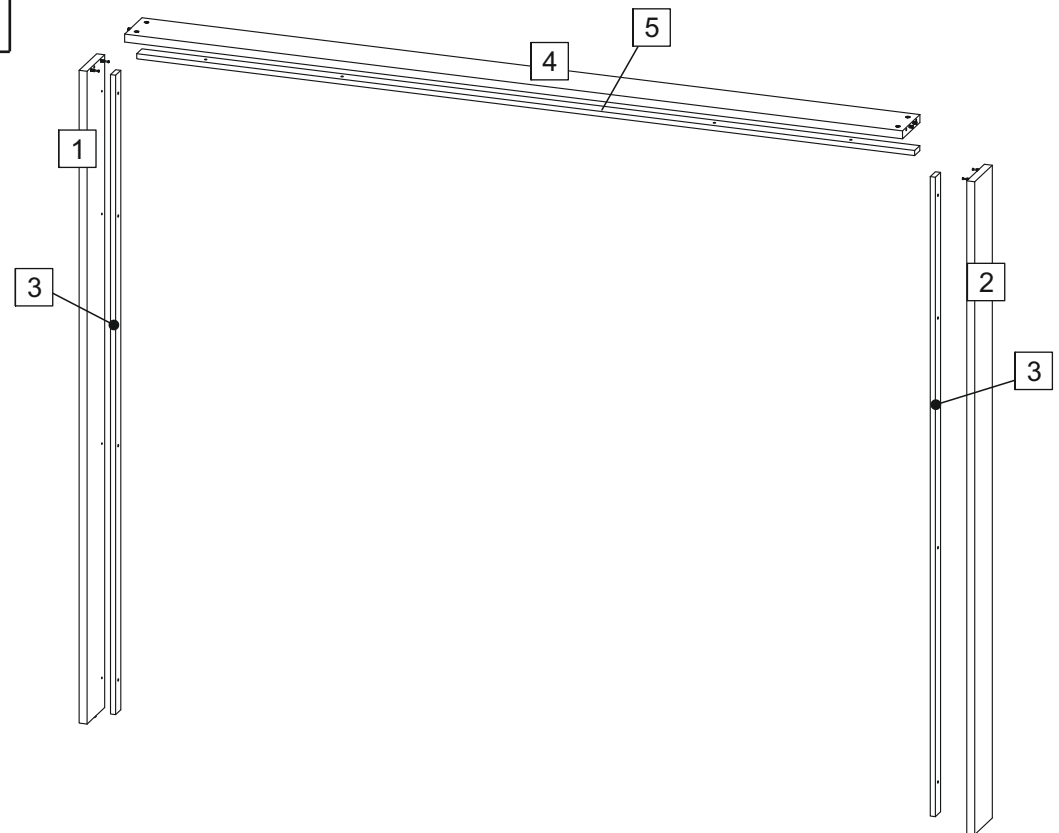
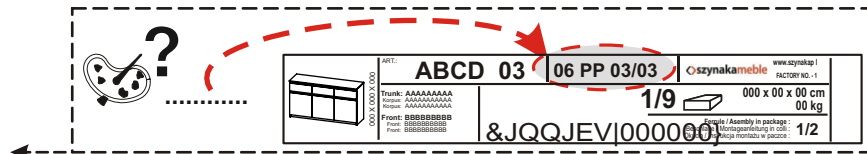

0 10 20 30 40 50 60 70 80 90 100 110 120 130 140 150 160 170 180 190 200



1

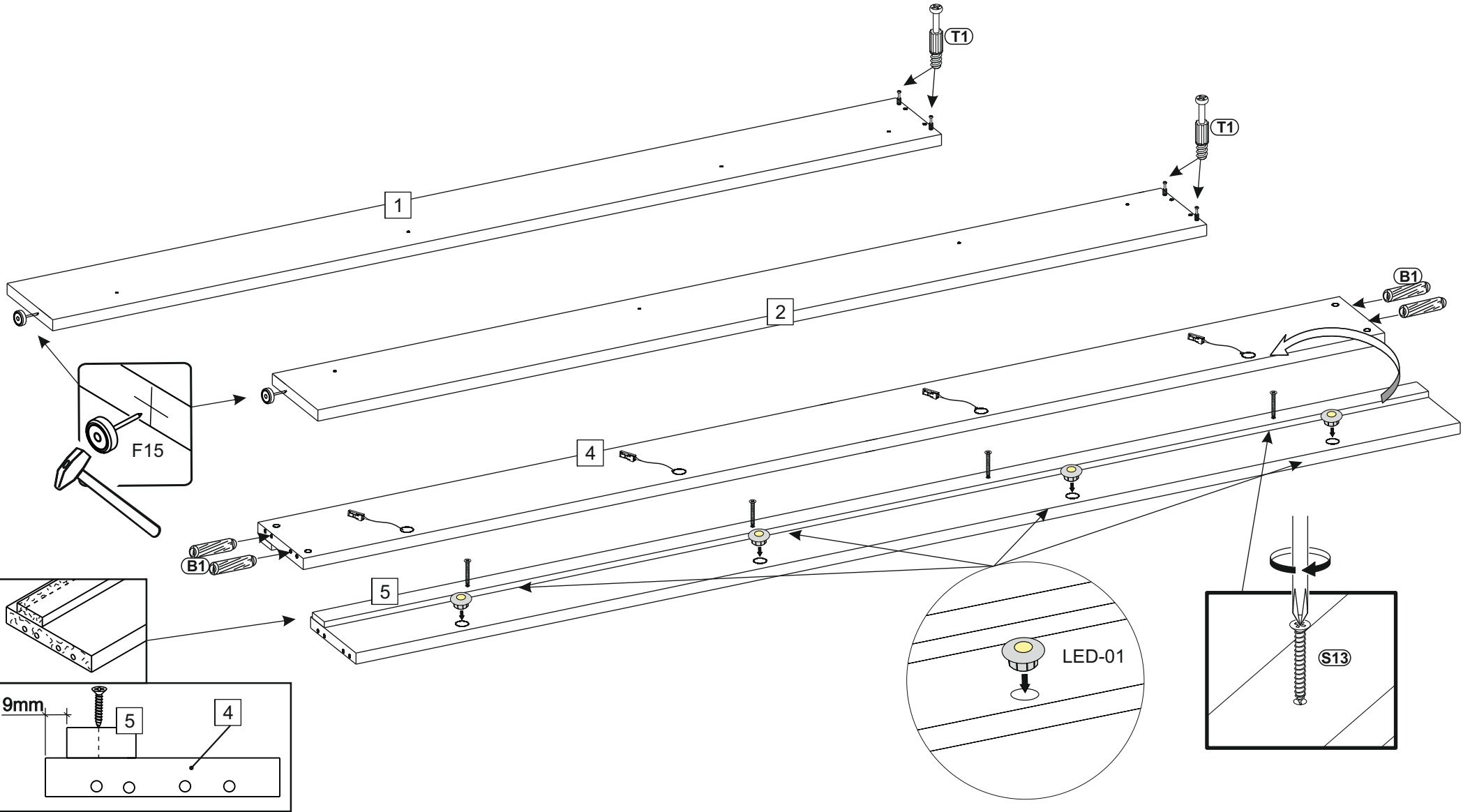
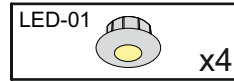
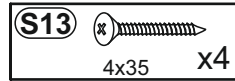
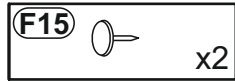
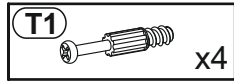
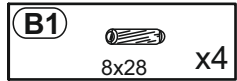

2

